

Cu-Pip

STD-000479-0025

Configured Product

CCT _____

3000K

Beam _____

Flood 35.2°

Cable Length _____

500mm

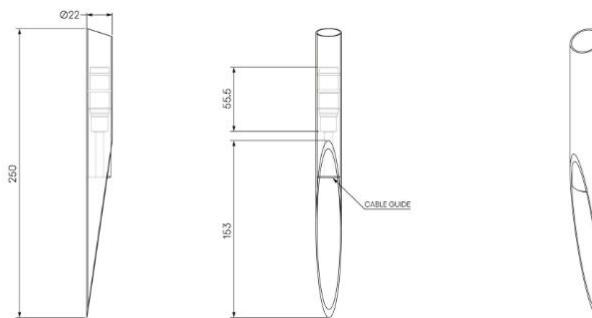
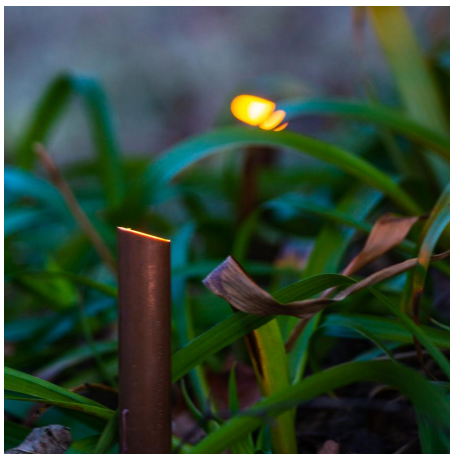

Award-winning exterior rated spike mounted light, designed to maintain precise focus with ease.

Product Description

The Cu-Pip design originated from a desire to create a simple, pared-back spike light.

Simplicity, durability, and minimal points of failure were key drivers. Equally important was minimising the overall manufacturing process and resource use. That's why Cu-Pip shares a large number of its build with Pipien.

The outer housing, machined from a single copper pipe, integrates both the ground spike and anti-glare snoot into a single artifact. With its natural finish, compact form, and elegant cable exit, the Cu-Pip almost disappears in any landscape. The internal LED module can be specified with a range of colour temperatures and site-changeable optics to hone the beam angle and glare control.

Key Features

- Robust construction: made from copper. Specialist finishes available on request.
- High levels of glare control and interchangeable optics.
- Advanced dimming options: DALI, 0-10V, and Wireless dimming, down to 0.1%.
- High-performance lighting: up to 97 CRI LEDs.

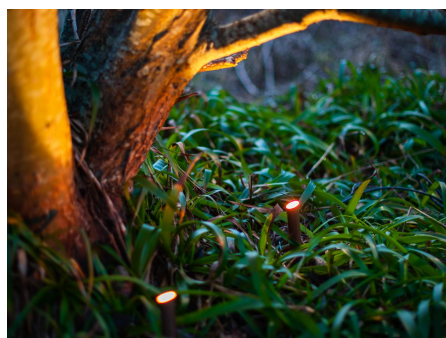
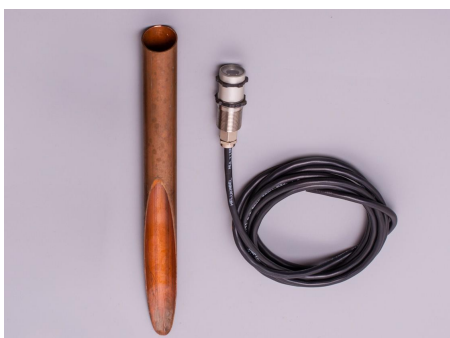

Compliance



Technical

Supply	Remote constant current LED driver required
Light source	SL Type S
Initial output	95 CRI 1.4W 2.75Vf at 500mA 2700K · 139lm · 99lm/W 3000K · 148lm · 105lm/W 3500K · 158lm · 112lm/W 4000K · 169lm · 120lm/W
Light distribution	Medium 22.9° Flood 35.2° Wide Flood 50.7°
Lumen maintenance	L70 B50 >66,000 hours
Colour consistency	2 SDCM
Colour maintenance	± 0.007 Δu'v'
IP rating	IP66
Weight	0.17kg

Service Commitment

