

## Mushroom

STD-000411-0142

### Configured Product

Length \_\_\_\_\_

1205mm

Finish \_\_\_\_\_

Matt Black

No. of Circuits \_\_\_\_\_

One (Single Colour)

Mushroom Type \_\_\_\_\_

Desert Spike

Circuit 1 CCT \_\_\_\_\_

2700K

Circuit 1 CRI \_\_\_\_\_

95CRI

Circuit 2 CCT \_\_\_\_\_

N/A

Circuit 2 CRI \_\_\_\_\_

N/A

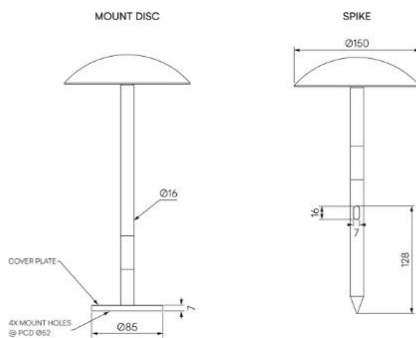

Exterior landscape accent lighting system, designed for both soft and hard landscaping applications, it can be used both in ground and on tabletops.

## Product Description

The Mushroom is an IP66 rated exterior accent light, designed to provide a soft, low level, wide and 360° lighting distribution via a customised impact resistant frosted diffuser system, providing a BUG rating of B0 U0 G0.

Both spike and fixed mount plates available.

Machined from recycled aluminium with an anodised and powder-coated finish for enhanced durability.

## Key Features

- Sustainable construction: made from recycled aluminium with a weather resistant long-lasting anodised and powder-coated finish. Specialist finishes available on request.
- Advanced dimming options: DALI, 0-10V, DMX and Wireless dimming, down to 0.1%.
- High-performance lighting: up to 97 CRI LEDs.
- Tuneable White and special SPD LEDs such as Reds or PC Amber are available on request.
- Ground spike and fixed mount plate options available for soft and hard landscaping applications.



## Compliance



## Technical

Supply	Remote constant current LED driver required
Light source	SL Star
Initial output	95 CRI 8.4W 16.5Vf at 500mA  2700K · 834lm · 99lm/W 3000K · 888lm · 105lm/W 3500K · 948lm · 112lm/W 4000K · 1014lm · 120lm/W
Light distribution	Downward distribution 100.7°
Lumen maintenance	L70 B50 >66,000 hours
Colour consistency	2 SDCM
Colour maintenance	$\pm 0.007 \Delta u'v'$
IP rating	IP66
Weight	0.825kg

## Service Commitment

