

Mushroom

STD-000411-0094

Configured Product

Length _____

305mm

Finish _____

XAL Classic 34 Bronze

No. of Circuits _____

One (Single Colour)

Mushroom Type _____

Desert Spike

Circuit 1 CCT _____

4000K

Circuit 1 CRI _____

Custom

Circuit 2 CCT _____

N/A

Circuit 2 CRI _____

N/A

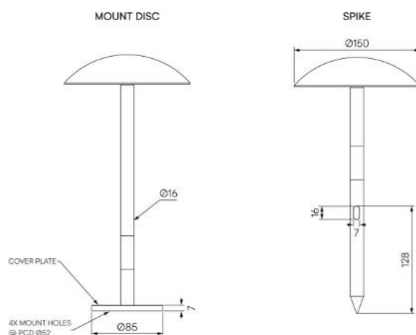

Exterior landscape accent lighting system, designed for both soft and hard landscaping applications, it can be used both in ground and on tabletops.

Product Description

The Mushroom is an IP66 rated exterior accent light, designed to provide a soft, low level, wide and 360° lighting distribution via a customised impact resistant frosted diffuser system, providing a BUG rating of B0 U0 G0.

Both spike and fixed mount plates available.

Machined from recycled aluminium with an anodised and powder-coated finish for enhanced durability.

Key Features

- Sustainable construction: made from recycled aluminium with a weather resistant long-lasting anodised and powder-coated finish. Specialist finishes available on request.
- Advanced dimming options: DALI, 0-10V, DMX and Wireless dimming, down to 0.1%.
- High-performance lighting: up to 97 CRI LEDs.
- Tuneable White and special SPD LEDs such as Reds or PC Amber are available on request.
- Ground spike and fixed mount plate options available for soft and hard landscaping applications.



Compliance



Technical

Supply	Remote constant current LED driver required
Light source	SL Star
Initial output	95 CRI 8.4W 16.5Vf at 500mA 2700K · 834lm · 99lm/W 3000K · 888lm · 105lm/W 3500K · 948lm · 112lm/W 4000K · 1014lm · 120lm/W
Light distribution	Downward distribution 100.7°
Lumen maintenance	L70 B50 >66,000 hours
Colour consistency	2 SDCM
Colour maintenance	± 0.007 $\Delta u'v'$
IP rating	IP66
Weight	0.825kg

Service Commitment

