

## Amanita

STD-000409-0038

### Configured Product

CCT \_\_\_\_\_

2700K

Finish \_\_\_\_\_

Matt Black

Mounting Method \_\_\_\_\_

Spike

Cable Length \_\_\_\_\_

500mm

Stem Height \_\_\_\_\_

400mm

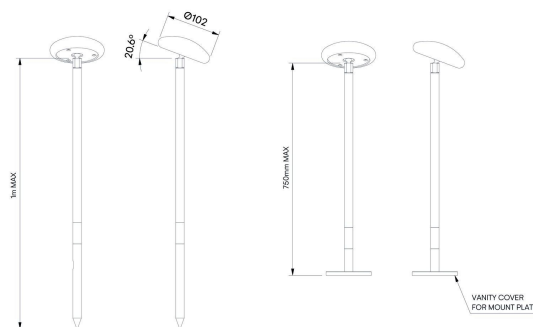
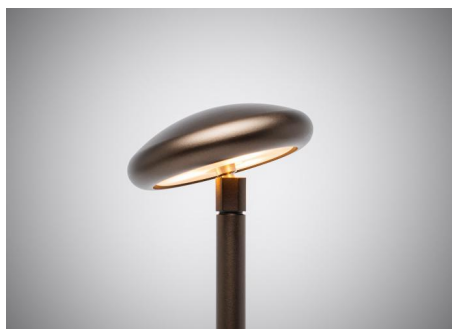

Exterior landscape accent lighting system, designed for both soft and hard landscaping applications, it can be used both in ground and on tabletops.

### Product Description

The Amanita is a small form factor IP66 rated exterior accent light, designed to provide a soft, low level, 360° lighting distribution via a customised impact resistant frosted diffuser.

When orientated directly downwards the product provides a **BUG rating** of B0 U0 G0.

Providing up to 20.6° of lockable tilt adjustment and both spike and fixed mount plates available.

### Key Features

- Sustainable construction: made from recycled aluminium with a weather resistant long-lasting anodised and powder-coated finish. Specialist finishes available on request.
- Versatile adjustment providing up to 20.6° of tilt with locking mechanism.
- Advanced dimming options: DALI, 0-10V, and Wireless dimming, down to 0.1%.
- High-performance lighting: Up to 97 CRI LEDs.
- Special SPD LEDs available on request.
- Ground spike and fixed mount plate options available for soft and hard landscaping applications.

## Compliance



## Technical

Supply Remote constant current LED driver required

Light source SL Star

Initial output 95 CRI 6W 8.4Vf at 700mA

2700K · 537lm · 90lm/W

3000K · 576lm · 96lm/W

3500K · 612lm · 102lm/W

4000K · 657lm · 110lm/W

Light distribution Downward 96.2°

Lumen maintenance L70 B50 >66,000 hours

Colour consistency 2 SDCM

Colour maintenance  $\pm 0.007 \Delta u'v'$

IP rating IP66

Weight 0.65kg

---

## Service Commitment

