

Amanita

STD-000409-0021

Configured Product

CCT _____

2700K

Finish _____

XAL Classic 34 Bronze

Mounting Method _____

Spike

Cable Length _____

500mm

Stem Height _____

300mm

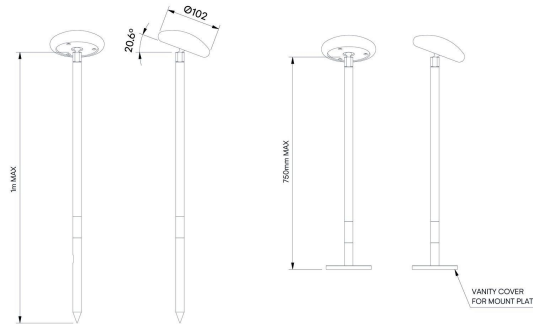

Exterior landscape accent lighting system, designed for both soft and hard landscaping applications, it can be used both in ground and on tabletops.

Product Description

The Amanita is a small form factor IP66 rated exterior accent light, designed to provide a soft, low level, 360° lighting distribution via a customised impact resistant frosted diffuser.

When orientated directly downwards the product provides a **BUG rating** of B0 U0 G0.

Providing up to 20.6° of lockable tilt adjustment and both spike and fixed mount plates available.

Key Features

- Sustainable construction: made from recycled aluminium with a weather resistant long-lasting anodised and powder-coated finish. Specialist finishes available on request.
- Versatile adjustment providing up to 20.6° of tilt with locking mechanism.
- Advanced dimming options: DALI, 0-10V, and Wireless dimming, down to 0.1%.
- High-performance lighting: Up to 97 CRI LEDs.
- Special SPD LEDs available on request.
- Ground spike and fixed mount plate options available for soft and hard landscaping applications.

Compliance



Technical

Supply Remote constant current LED driver required

Light source SL Star

Initial output 95 CRI 6W 8.4Vf at 700mA

2700K · 537lm · 90lm/W

3000K · 576lm · 96lm/W

3500K · 612lm · 102lm/W

4000K · 657lm · 110lm/W

Light distribution Downward 96.2°

Lumen maintenance L70 B50 >66,000 hours

Colour consistency 2 SDCM

Colour maintenance $\pm 0.007 \Delta u'v'$

IP rating IP66

Weight 0.65kg

Service Commitment

