

The Workplace Light (Desk Clamp)

STD-000400-0014

Configured Product

Finish _____

TBC

End Caps _____

TBD

Stem Height _____

450mm

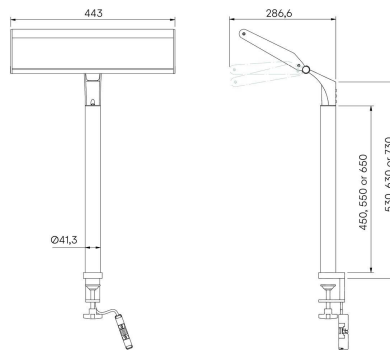

Versatile task lighting system, designed to provide good quality working light whilst enhancing alertness, improving mood and sleep.

Product Description

The Workplace Light has been at the heart of research conducted with UK lighting designers and UCL indicating that working with >250 m-EDI lux vertical to the eye for the earlier portion of the day (countered with significantly less in the latter part of the day, and virtually none after bedtime), can improve productivity, mood and sleep. Fitted with innovative optical system to ensure maximum visual comfort and optimised m-EDI lux delivery. Includes both a desk clamp and through-desk mounted version. Also capable of monitor mounting.

Key Features

- Designed based on extensive research examining healthy light.
- Innovative optical system to ensure visual comfort and optimisation of m-EDI lux delivery.
- Sustainable construction: made from recycled aluminium with a long-lasting anodised finish. Specialist finishes available on request.
- Advanced dimming options: Wireless dimming, down to 0.1%.



Compliance



Service Commitment



Technical

Light Source

95 CRI

1505lm

delivered output at

2700K

1468lm

delivered output at

5700K

Light

93.5°

Distribution