

Surf Type G

STD-000296-0130

Configured Product

CCT _____

2700K

Beam _____

TBC

Finish _____

TBC

Attachments _____

TBC

Cable route _____

TBC

Secondary Lensing Accessories _____

With accessories

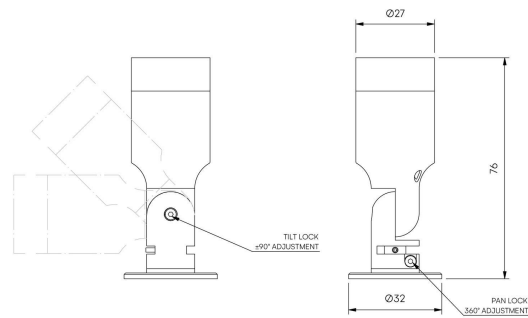

Compact lighting system for Museum, Gallery and Retail displays.

Product Description

The Surf Type G is a compact adjustable and highly efficient miniature fixture designed to provide precise illumination for Museum, Gallery and Retail applications. With both pan and tilt locking mechanisms.

Constructed from precision-machined recycled aluminium, the system features an anodised finish for enhanced durability and aesthetics.

Key Features

- Sustainable construction: made from recycled aluminium with a long-lasting anodised finish. Specialist finishes available on request.
- Tree system height and number of plug in points can be specified.
- Fixed interchangeable optics available ranging from Very narrow to Wide Flood to elliptical beam options.
- Lockable Tilt and Pan mechanisms.
- Advanced dimming options: DALI, 0-10V, DMX and Wireless dimming, down to 0.1%.
- High-performance lighting: Up to 97 CRI LEDs



Compliance



Technical

Supply	Remote constant current LED driver required
Light source	SL Star
Initial output	95CRI 3.1W 2.9Vf at 1050mA 2700K · 251lm · 81lm/W 3000K · 268lm · 86lm/W 3500K · 285lm · 92lm/W 4000K · 304lm · 97lm/W
Light distribution	Very Narrow 9° Narrow 12.6° Medium 20.6° Flood 36.3° Wide Flood 47.1° Elliptical 9.7° x 46.1°
Lumen maintenance	L70 B50 >66,000 hours
Colour consistency	2 SDCM
Colour maintenance	± 0.007 Δu'v'
IP rating	IP20
Weight	0.07kg

Service Commitment

