

Path Bandit

STD-000100-0008

Configured Product

CCT _____

2700K

Length _____

Standard Length

Finish _____

Standard Painted

Cable Length _____

500mm

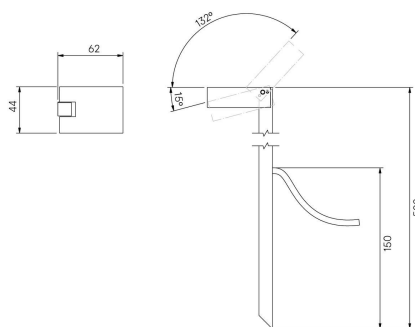

Low level exterior rated adjustable spike light, providing soft and wide light distribution for pathways.

Product Description

The Path Bandit is an IP66 rated pathway light. Machined from recycled aluminium. It is useful for various applications such as pathway and step lighting and can be used both internally or externally.

Key Features

- Tilt adjustable and lockable luminaire head.
- Soft and wide beam wash effect.
- Advanced dimming options: DALI, 0-10V, and Wireless dimming, down to 0.1%.
- High-performance lighting: up to 97 CRI LEDs.

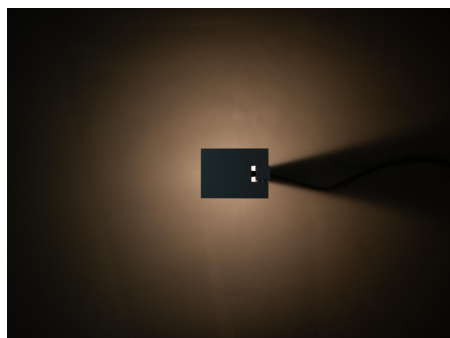

Compliance



Technical

Supply Remote constant current LED driver required

Light source SL Star

Initial output 95CRI 2W 2.8Vf at 700mA

2700K · 179lm · 90lm/W

3000K · 192lm · 96lm/W

3500K · 204lm · 102lm/W

4000K · 219lm · 110lm/W

Light distribution Downward distribution
82.6°

Lumen maintenance L70 B50 >66,000 hours

Colour consistency 2 SDCM

Colour maintenance $\pm 0.007 \Delta u'v'$

IP rating IP66

Weight 0.206kg

Service Commitment

