

Baby Badger

STD-000072-0026

Configured Product

CCT _____

3000K

Beam _____

Elliptical 14.2° x 47.6°

Finish _____

Anodised Clear

Mounting Method _____

First Fix Installation Sleeve (Specified Separately)

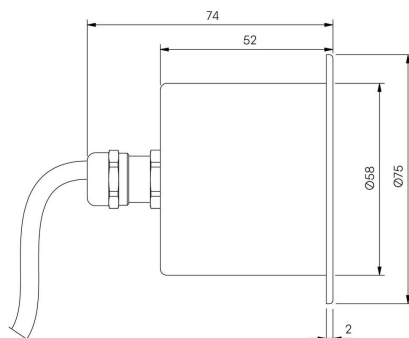

Exterior in-ground recessed adjustable and lockable uplighter, for enhancing architectural details, gardens and pathways.

Product Description

The Baby Badger is a small form factor IP66 rated adjustable and lockable exterior up light, designed to precisely highlight textures, add depth to trees, sculptures, facades and other outdoor features. Perfect for both commercial and residential applications, ideal for bringing landscapes to life after dark.

Key Features

- Sustainable construction: made from recycled aluminium with a weather resistant long-lasting anodised and powder-coated finish. Specialist finishes available on request.
- Adjustment providing up to $\pm 12^\circ$ of tilt with locking mechanism and pan rotation.
- Interchangeable optics to allow Very Narrow to Wide Flood to elliptical beam options and a toughened glass lens.
- Advanced dimming options: DALI, 0-10V, and Wireless dimming, down to 0.1%.
- High-performance lighting: Up to 97 CRI LEDs.
- First fix Installation sleeve available for mounting.

Compliance



Technical

Supply Remote constant current LED driver required

Light source SL Star

Initial output 95 CRI 2W 2.8Vf at 700mA

2700K · 179lm · 90lm/W

3000K · 192lm · 96lm/W

3500K · 204lm · 102lm/W

4000K · 219lm · 110lm/W

Light distribution Very Narrow 8.8°
Narrow 12.6°
Medium 22.3°
Flood 34.3°
Wide Flood 68.1°
Elliptical 14.2° x 47.6°

Lumen maintenance L70 B50 >66,000 hours

Colour consistency 2 SDCM

Colour maintenance $\pm 0.007 \Delta u'v'$

IP rating IP66

Weight 0.33kg

Service Commitment

