

Orb

STD-000047-0018

Configured Product

CCT _____

2700K

Finish _____

Anodised Clear

Mounting Method _____

Screw

Diffuser _____

Frosted

Cable Length _____

2000mm

Size _____

ø98mm

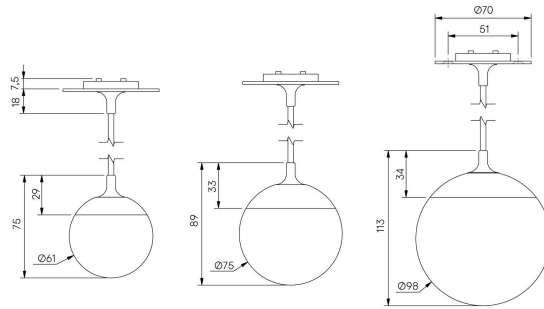

Decorative globe pendant, for enhancing dining, workspace and feature areas.

Product Description

The Orb is a family of three sizes of decorative pendants, for either stand alone use or integration into a larger feature chandelier. Available in three standard diameters, it can be provided with recycled clear, satin frosted or Opal diffuser options.

Constructed from precision-machined recycled aluminium, the product features an anodised finish with the option of a powder-coated finish for enhanced durability and aesthetics.

Key Features

- Sustainable construction: made from recycled aluminium with a long-lasting anodised and powder-coated finish. Specialist finishes available on request.
- Three different diameter and diffuser options.
- RGBW and Tuneable White options for dynamic lighting effects.
- Height adjustable suspension and power cabling
- Customised mounting solutions for both stand alone and large feature lighting options.
- Advanced dimming options: DALI, 0-10V, DMX and Wireless dimming, down to 0.1%.
- High-performance lighting: up to 97 CRI LEDs with interchangeable optical systems.

Acrylic Diffuser

While both opalised and frosted acrylic diffuse light, our 70% recycled opalised acrylic has a milky, translucent and terrazzo like appearance that blocks more light and hides details, whereas frosted acrylic has a matte surface that allows more light transmission and provides a degree of obscuration.

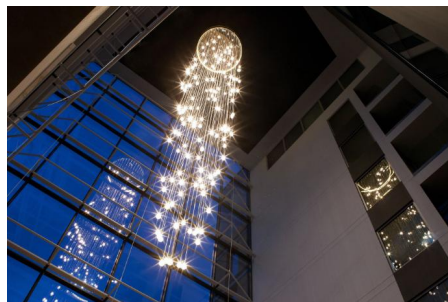

STOANE LIGHTING

EQUIPMENT DESIGN + MANUFACTURE

Orb

STD-000047-0018

Compliance



Technical

Supply	Remote constant current LED driver required
Light source	SL Star
Initial output	95CRI 2W 2.8Vf at 700mA 2700K · 179lm · 90lm/W 3000K · 192lm · 96lm/W 3500K · 204lm · 102lm/W 4000K · 219lm · 110lm/W
Light distribution	Ø61mm Opalised 217.7° Ø61mm Frosted 121° Ø75mm Opalised 247.2° Ø75mm Frosted 113.5° Ø98mm Opalised 267.4° Ø98mm Frosted 107.9°
Lumen maintenance	L70 B50 >66,000 hours
Colour consistency	2 SDCM
Colour maintenance	± 0.007 $\Delta u'v'$
IP rating	IP20
Weight	Ø61mm 0.22kg Ø75mm 0.35kg Ø98mm 0.7kg

Service Commitment

