

# STOANE LIGHTING

EQUIPMENT DESIGN + MANUFACTURE

## Toad Type X STD-000024-0013

High-performance exterior spotlight system, for ceiling and wall mounting to illuminate exterior architectural details and landscape illumination.

### Product Description

The Toad Type X is a high power IP66 exterior rated, adjustable and lockable spotlight.

Constructed from precision-machined recycled aluminium, the spotlight features an anodised and powder-coated finish for enhanced durability and aesthetics.

Provided with interchangeable optics from Very Narrow to Wide Flood, additional lenses can be added for glare control or to create elliptical beam spreads.

### Key Features

- Sustainable Construction: Made from recycled aluminium with a weather resistant long-lasting anodised and powder-coated finish. Specialist finishes available on request.
- Fixed optics can be easily swapped from Very Narrow to Flood options, capable of holding up to two additional lens accessories.
- Snoot and Cowl options available.
- Advanced Dimming Options: DALI, 0-10V, DMX and Wireless dimming, down to 0.1%.
- High-Performance Lighting: Up to 98 CRI LEDs with interchangeable optical systems.

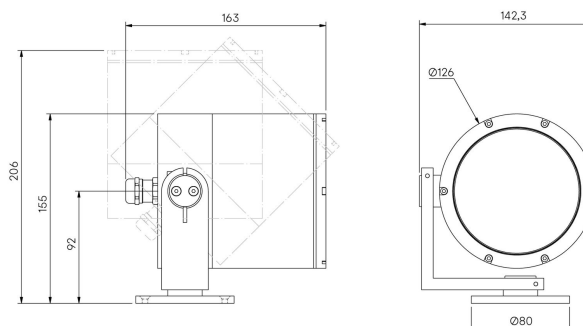

# STOANE LIGHTING

EQUIPMENT DESIGN + MANUFACTURE

## Toad Type X STD-000024-0013

### Configured Product

Light source

9.8mm LES

CCT

2700K

CRI

90

Beam

Flood 42.8°

Finish

Please contact us for custom finishing requirements

Standard Painted

Attachments

Please scroll for options and part numbers.

TBC

Secondary Lensing Accessories

Please scroll for options and part numbers.

With accessories